

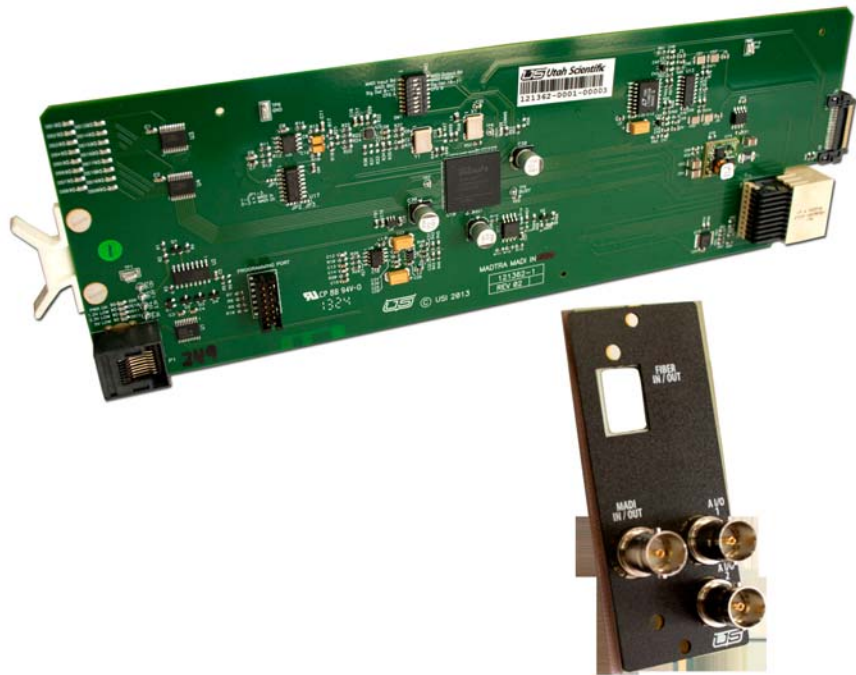

---

## MADI Terminal



*Setup and Operations Guide*

---

---

---

---

## ***MADI Terminal - Operations Guide***

- Document Number: 82102-0083
- Document Version: 1.0
- Date: November 23, 2015
- Printed in U.S.A.

### ***Copyrights and Trademarks***

© 2015 Utah Scientific, Inc., All rights reserved. Any use or reproduction of this guide's contents without the prior written consent of Utah Scientific, Inc. is strictly prohibited.

- MADI is a trademark of Utah Scientific, Inc.
- Windows, Windows XP, and Windows 7 are registered trademarks of Microsoft Corporation.
- All other product names and any registered or unregistered trademarks mentioned in this guide are used for identification purposes only and remain the exclusive property of their respective owners.

### ***Notice***

Information contained in this guide is subject to change without notice or obligation. While every effort has been made to ensure that the information is accurate as of the publication date, Utah Scientific, Inc. assumes no liability for errors or omissions. In addition, Utah Scientific, Inc. assumes no responsibility for damages resulting from the use of this guide.

### ***FCC Compliance (USA) and Digital Equipment Compliance (Canada)***

This equipment has been tested and found to comply with the limits for a Class A, digital device, pursuant to Part 15, Subpart B of the FCC Rules and the Canadian EMC Requirement (ICES-003). These limits are designed to provide reasonable protection against harmful interference when the equipment is operated in a commercial environment. This equipment generates, uses, and can radiate radio frequency energy and, if not installed and used in accordance with the instruction manual, may cause harmful interference to radio communications. Operation of this equipment in a residential area is likely to cause harmful interference, in which case, the user will be required to correct the interference at their own expense. Shielded cables must be used to ensure compliance with the FCC Class A limits.

---

---

## ***Declaration of Conformity***

### **Utah Scientific, Inc.**

4750 Wiley Post Way, Suite 150  
Salt Lake City, Utah 84116-2878 U.S.A.

We declare our sole responsibility that the Utah-400 Digital Routing Switcher is in conformance with the following standards:

#### **Emission**

- EN55022:1994+A1&A2

#### **Immunity**

- EN55024:1998
- EN61000-3-2
- EN61000-3-3

#### **Safety**

- IEC 60950-1:2001 /EN 60950-1:2001

Following the provisions of the Directive(s) of the Council of the European Union:

- EMC Directive 89/336/EED
- Low Voltage Electrical Directive 72/23/EEC

Utah Scientific, Inc. hereby declares that the product specified above conforms to the above Directive(s) and Standard(s).



---

---

## ***Important Safeguards and Notices***

This section provides important safety guidelines for the Operator and Service Personnel. Specific warnings and cautions are found throughout the guide where they apply, but may not appear here. Please read and follow the important safety information, specifically those instructions related to risk of fire, electric shock, or injury to persons.

### **Safety Symbols**



- Hazardous Voltage symbol



- Caution symbol. The product is marked with this symbol when it is necessary to refer to the manual to prevent damage to the product.

### **Warnings**

Please observe the following important warnings:



- Any instructions in this guide that require opening the chassis, changing a power supply, or removing a board, should be performed by qualified personnel only. To reduce the risk of electric shock, do not perform any service unless you are qualified to do so.
- Heed all warnings on the unit and in the operating instructions.
- Do not use this product in or near water. Disconnect AC power before installing any options or servicing the unit unless instructed to do so by this manual.
- This product is grounded through the power cord ground conductor. To avoid electric shock, plug the power cord into a properly wired receptacle before connecting the product inputs or outputs.
- Route power cords and other cables so they won't be damaged.
- The AC receptacle (socket) should be located near the equipment and be easily accessible.
- Disconnect power before cleaning. Do not use any liquid or aerosol cleaner - use only a damp cloth.



- Dangerous voltages exist at several points in this product. To avoid personal injury, do not touch exposed conductors and components while power is on. Do not insert anything into either of the systems two-power supply cavities with power connected.
- Do not wear hand jewelry or watches when troubleshooting high current circuits, such as power supplies. During installation, do not use the door handles or front panels to lift the equipment as they may open abruptly and injure you.
- To avoid fire hazard when replacing fuses, use only the specified correct type, voltage and current rating as referenced in the appropriate parts list for this product. Always refer fuse replacement to qualified service personnel.
- Have qualified personnel perform safety checks after any service.

#### **Cautions**

Please observe the following important cautions:



- When installing this equipment do not install power cords to building surfaces. To prevent damage when replacing fuses, locate and correct the problem that caused the fuse to blow, before reconnecting power.
- Use only specified replacement parts

#### **Notices**

Please observe the following important notes:



- When the adjacent symbol is indicated on the chassis, please refer to the manual for additional information.
- For the HD-2020 Chassis and Master Control Panel, refer to “Connecting and Disconnecting Power” - Chapter 2 (Hardware Installation).

---

---

## *Company Information*

### **Utah Scientific, Incorporated**

**4750 Wiley Post Way, Suite 150  
Salt Lake City, Utah 84116-2878 U.S.A.**

- Telephone: +1 (801) 575-8801
- FAX: +1 (801) 537-3098
- Technical Services (voice): +1 (800) 447-7204
- Technical Services (FAX): +1 (801) 537-3069
- E-Mail -General Information: [info@utsci.com](mailto:info@utsci.com)
- E-Mail -Technical Services: [service@utsci.com](mailto:service@utsci.com)
- World Wide Web: <http://www.utahscientific.com>
- **After Hours Emergency:** +1 (800) 447-7204. Follow the menu instructions for Emergency Service.

---

---

## ***Warranty Policies***

### **Hardware Warranty**

Utah Scientific, Inc. warrants to the original purchaser that the Utah Scientific hardware is free from defects in materials and workmanship and will perform substantially in accordance with the accompanying written materials under normal use and service for a period of ten (10) years from the date of shipment. Any implied warranties on hardware are limited to ten (10) years. Some states/jurisdictions do not allow limitations on duration of an implied warranty, so the above limitation may not apply to certain specific purchasers.

### **Software Warranty**

Utah Scientific warrants that the software will perform substantially in accordance with the accompanying written materials for a period of one (1) year from the date of shipment.

### **Customer Remedies**

For the first one (1) year after purchase of the software and the first ten (10) years after the date of purchase of the hardware, Utah Scientific's and its suppliers' entire liability and purchaser's exclusive remedy shall be, at Utah Scientific's option, either:

- Return of the price paid, or
- Repair or replacement of the software or hardware that does not meet the above warranties and is returned to Utah Scientific under the returned materials authorization (RMA) process with freight and forwarding charges paid.

After the initial warranty periods, purchaser's exclusive remedy is the repair or replacement of the hardware upon payment of a fixed fee to cover handling and service costs based on Utah Scientific's then-current price schedule. The above warranties are void if failure of the software or hardware has resulted from an accident, abuse, or misapplication. Any replacement software or hardware will be warranted for the remainder of the original warranty period or thirty (30) days, whichever is longer.

---

---

***No other warranties.*** To the maximum extent permitted by applicable law, Utah Scientific and its suppliers disclaim all other warranties, either express or implied, including, but not limited to implied warranties of merchantability and fitness for a particular purpose, with regard to the software, the accompanying written materials, and any accompanying hardware. This limited warranty gives the purchaser specific legal rights. These rights may vary in certain states/ jurisdictions.

***No liability for consequential damages.*** To the maximum extent permitted by applicable law, in no event shall Utah Scientific or its suppliers be liable for any damages whatsoever (including without limitation, damages for loss of business profits, business interruption, loss of business information, or any other pecuniary loss) arising out of the use of or inability to use Utah Scientific products, even if Utah Scientific has been advised of the possibility of such damages. Because some states/jurisdictions do not allow the exclusion or limitation of liability for consequential or incidental damages, the above limitation may not apply in those circumstances.



---

*Table of Contents*

**CHAPTER 1      MADI Terminal**

General .....	1-1
System Setup Information .....	1-3
Unbalanced AES .....	1-3
Balanced AES .....	1-4
Analog Audio .....	1-5
MADI Configuration .....	1-6
MADI Terminal System Boards .....	1-7
AES Audio Input (121360-1) .....	1-7
Controls and Indicators .....	1-7
ADC Audio Input (121371-1) .....	1-9
Controls and Indicators .....	1-9
DAC Audio Output (121372-1) .....	1-10
Controls and Indicators .....	1-10
MADI Input (121362-1) .....	1-12
Controls and Indicators .....	1-12
MADI Output (121362-2) .....	1-13
Controls and Indicators .....	1-13
Balanced Digital Audio/Analog Audio (Pinout Connections) .....	1-15
Controller (121364-1) .....	1-17
Controls and Indicators .....	1-17
Fiber Interface - (Optional) .....	1-19
Specification Detail .....	1-19
SFP Use .....	1-20
Rear Panel Layout (basic configuration) .....	1-20

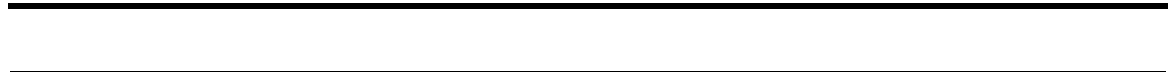



### General

The MADI Terminal is a 2RU chassis that has two primary functions, it converts AES or analog audio into a Multichannel Audio Digital Interface (MADI/AES10) and it converts Multichannel Audio Digital Interface into AES or analog audio. The MADI supports 32 pairs of 48 kHz digital audio. This unit is capable of reporting signal information and errors via an Ethernet port or serial port.

The chassis is made up of up to two power supplies, a controller board and two MADI bays. The system usually arrives with a single power supply unless a redundant one has been ordered. The controller board carries a CPU board and Timebase module that enable external communication and distribute clocks for DARS timing of audio signals. Each MADI bays consist of 3 audio I/O boards and a single MADI I/O board. The bays will be configured as MADI inputs or outputs and will mate up with their corresponding AES or analog audio boards.

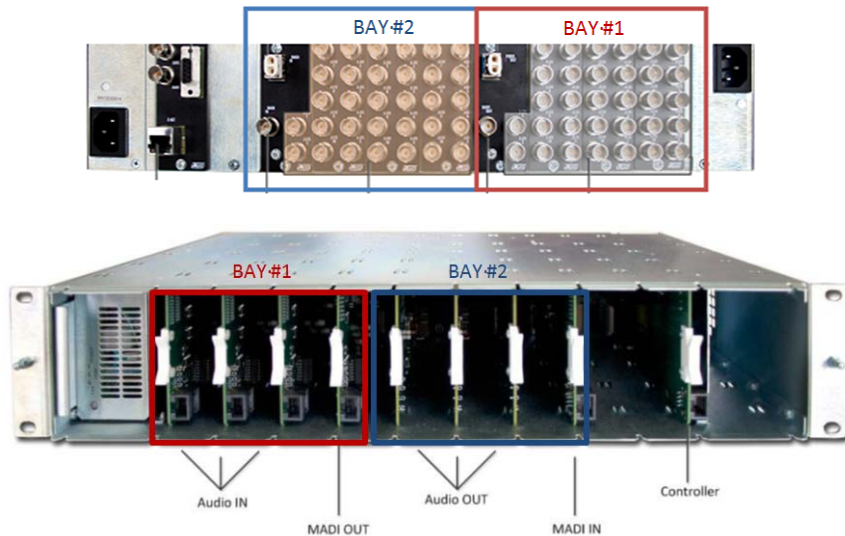

Figure 1-1. Chassis overview

**Note:** The above illustration contains the AES Unbalanced view. AES Balanced and analog configurations will contain different rear panel layouts.

---

The audio signals that make up the MADl streams will come from or be delivered to the input and output connectors as AES or analog signals. The MADl Output board receives 32 AES pairs that are individually analyzed and synchronized to the digital audio reference (DARS) and are processed into a MADl Stream that is available at the BNC and Fiber outputs. The MADl Input board receives a MADl signal from either the BNC or Fiber input and extracts the 32 AES3 digital audio signals and distributes them to the audio outputs.

In a MADl output configuration there will be three audio input boards and a MADl output board. In a MADl input configuration there will be a MADl input board and three audio output boards. These input and output boards each have the capability interfacing to 11 audio signals but because of connector sizes and only needing a total of 32 signals ( $3 \times 11 = 33$ ), some configurations will only use 10 of the 11 signal paths. Below you will find a detailed explanation of the rear panels and their requirements.



## System Setup Information

### Unbalanced AES

Unbalanced AES Inputs and Outputs will have 10 signals per input or output board making up 30 of the 32 pairs used in a MADI stream. The last two signals come from or are delivered to two BNCs located on the MADI board rear panel. In this configuration (unbalanced inputs) the SW1 switch #4 should be toward the CFG B silkscreen (“ON” position) to indicate the onboard AES input/output ports will be used for the last two signals.

**Note:** Cabling should always be completed from top to bottom, and right to left.

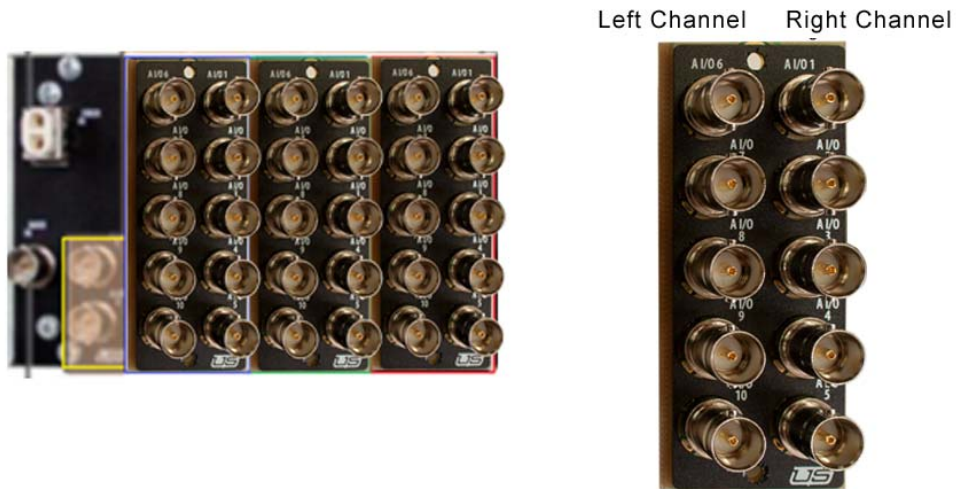

Figure 1-2. Unbalanced AES Inputs and Outputs

## Balanced AES

Balanced AES Inputs and Outputs will have 10 signals at the first board and 11 signals on the next two boards (10+11+11=32) making up 32 of the 32 pairs used in a MADi stream. The last two signals come from the last two I/O boards. In the balanced inputs configuration, the SW1 switch #4 should be toward the CFG A silkscreen (“OFF” position) to indicate the AES signals come from the I/O boards and not the onboard ports. In the D-SUB 37 drawing below, pins IOA10, IOB10 and IOC10 will be where signals 30 and 31 are on located in this balanced configuration.

**Note: Signal 30 will be the last signal on the second connector shown in the illustration (I/O 2). Signal 31 will be the last signal on the third connector displayed below (I/O 3).**

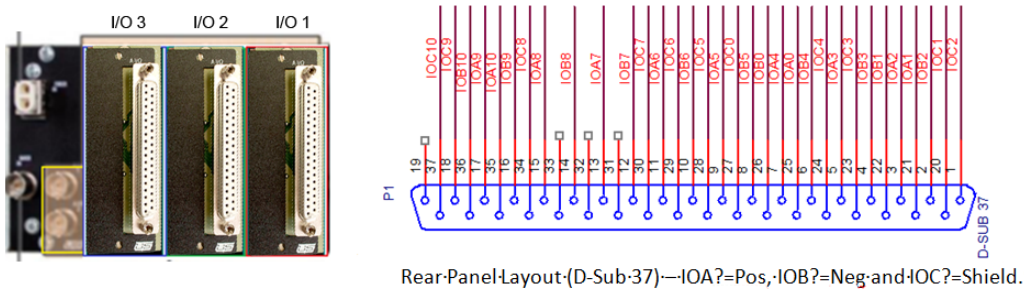

Figure 1-3. Rear Panel Layout (D-Sub 37) – IOA?=Pos, IOB?=Neg and IOC?=Shield.

**Note: Cabling should always be completed from top to bottom, and right to left.**



## Analog Audio

Analog audio Inputs and Outputs will have 10 signals at the first board and 11 signals on the next two boards (10+11+11=32) making up 32 of the 32 pairs used in a MADi stream. The last two signals come from the last two I/O boards. In the balanced inputs configuration, the SW1 switch #4 should be toward the CFG A silkscreen (“OFF” position) to indicate the AES signals come from the I/O boards and not the onboard ports. The D-SUB 37 pin connector pinout is the same as the AES pinout above. Below is the orientation of the left and right channels of the analog audio connectors.

**Note: Signal 30 will be the last signal on the second pair of connectors shown in the illustration below (I/O 2). Signal 31 will be the last signal on the third pair of connectors shown below labeled I/O 3.**

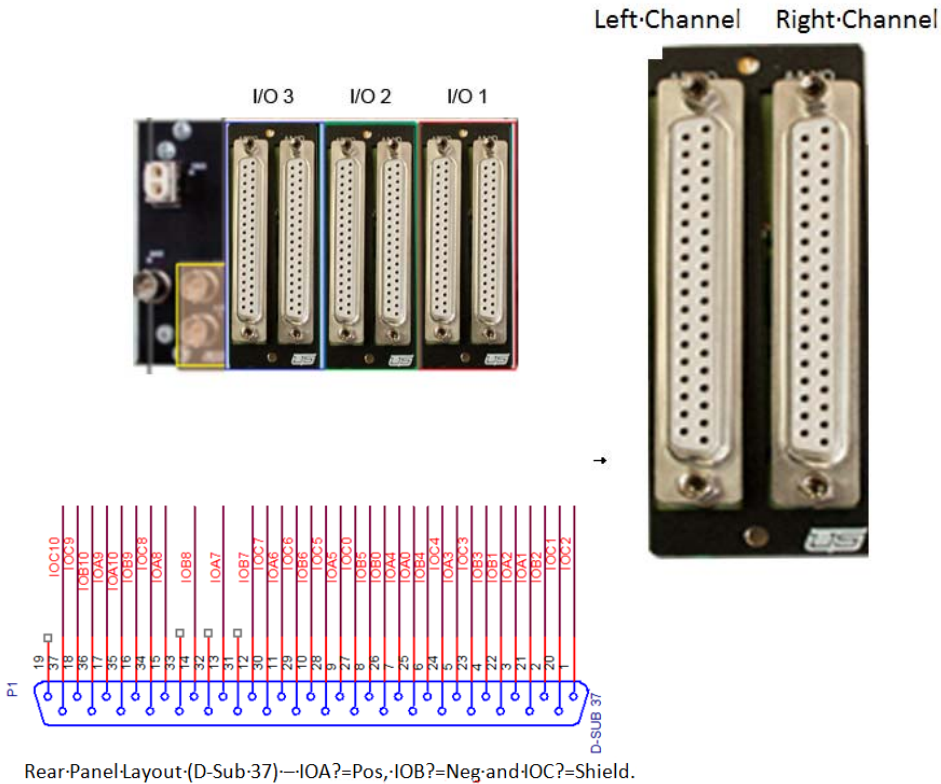

Figure 1-4. Analog Audio Inputs and Outputs

**Note: Cabling should always be completed from top to bottom, and right to left.**

---

## MADI Configuration

The MADI I/O boards have some configuration options that are setup with the dipswitch SW1 found near the middle top half of the board. These should be preconfigured at the factory before shipment.

**Table 1-1.**

MADI Input Bd	Selects the type of MADI board	MADI Output Bd
MADI BNC	Selects the type of MADI interface	MADI Fiber
Sig Det 0-15	elects which 16 signal detects are assigned to the LEDs at the front of the board	Sig Det 16-31
CFG A	CFG A selects balanced rear panels CFG B selects unbalanced rear panels	CFG B

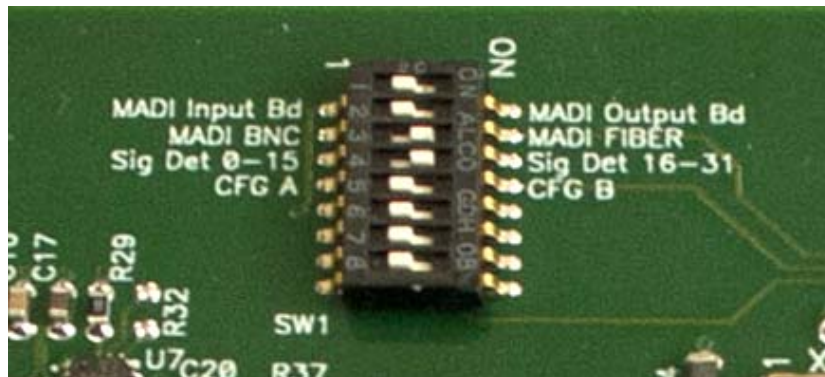

**Figure 1-5. MADI I/O Boards**





## MADI Terminal System Boards

### AES Audio Input (121360-1)

The AES Audio Input board receives up to 11 AES signals that are passed to the MADI Output board. The number of signals passed is determined by the slot the board is installed in and the type of rear panel interface used in the system. These signals are received and individually analyzed to see if they qualify for synchronization to the digital audio reference (DARS).



Figure 1-6. AES Audio Input (121360-1)

### Controls and Indicators

There are no controls on this card, other than P1. This is a standard UT400 diagnostic port that provides detailed operational status and control for this card.

There are four types of LED indicators present on the front edge on this card

1. PWR OK -> Power supply indicator (green). This is illuminated when the local power supplies are within tolerance.
2. DS1-11 (SIGDET1-11) -> Signal detection LEDs (green). This is illuminated when a valid digital audio signal is detected on the associated receiver input.
3. DS15-25 (SYNCDET1-11) -> Sync detection LEDs (yellow). This is illuminated when a valid input signal is found to be in sync with the router reference and is being processed accordingly.
4. 1.2V and 3.3V -> Power supply fail indicators (red). This is illuminated when local voltages fall out of 5% tolerance.

---

This board can be strapped for balanced or unbalanced interfaces by setting the jumpers JP2-JP12, located at the back of the board, to 1-2 for unbalanced and 2-3 for balanced (this will be set at the factory before shipping).

### **AES Audio Output (121361-1)**

The AES Audio Output board receives up to 11 AES signals from the MAD1 Output board and individually drives them to the system rear panel connectors. The number of signals passed is determined by the slot the board is installed in and the type of rear panel interface used in the system.

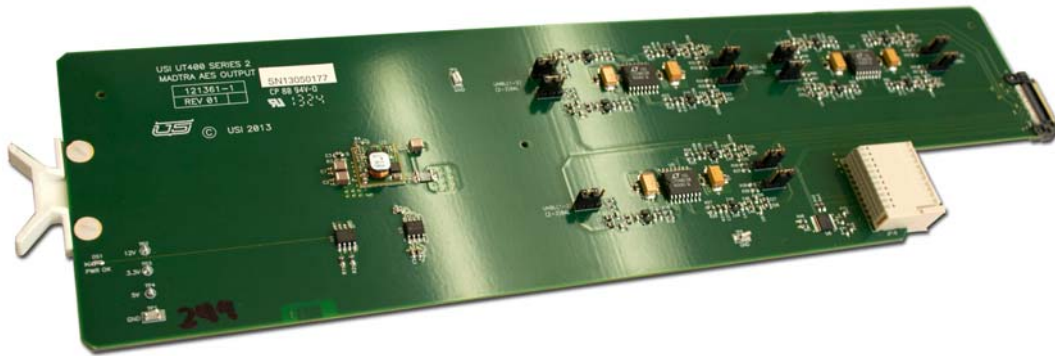

Figure 1-7. AES Audio Output (121361-1)

### **Controls and Indicators**

There are no controls on this card.

There is only one type of LED indicators present on the front edge on this card.

1. PWR OK -> Power supply indicator (green). This is illuminated when the local power supplies are within tolerance.

This board can be strapped for balanced or unbalanced interfaces by setting the jumpers JP1-9 and JP11-12, located at the back of the board, to 1-2 for unbalanced and 2-3 for balanced (this will be set at the factory before shipping).



## ADC Audio Input (121371-1)

The ADC Input board receives up to 11 L/R analog signals. These signals are received and individually converted into AES3 signals that are aligned to the digital audio reference (DARS). The number of signals passed is determined by the slot the board is installed in and the type of rear panel interface used in the system.

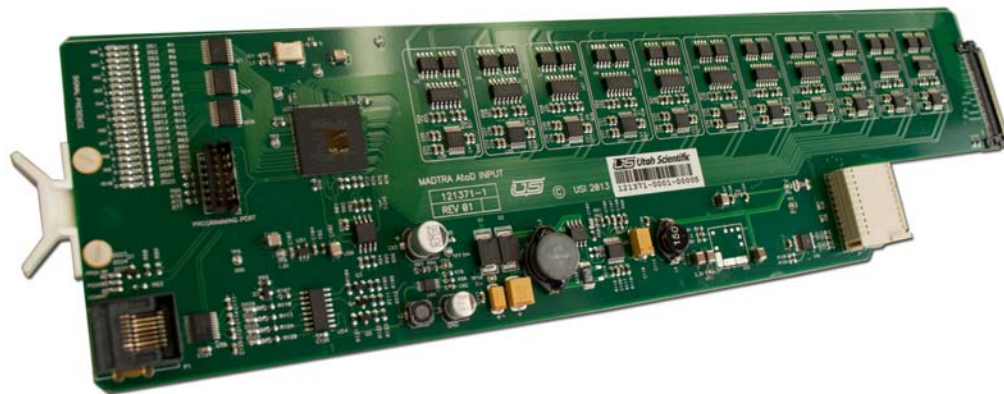

Figure 1-8. ADC Audio Input (121371-1)

### Controls and Indicators

There are no controls on this card, other than P1. This is a standard UT400 diagnostic port that provides detailed operational status and control for this card.

There are four types of LED indicators present on the front edge on this card.

1. PWR OK -> Power supply indicator (green). This is illuminated when the local power supplies are within tolerance.
2. DS1-22 -> odds (Left Signal Presence) -> Signal detection LEDs (green). This is illuminated when a valid audio signal is detected on the associated receiver input.
3. DS1-22 -> evens (Right Signal Presence) -> Signal detection LEDs (yellow). This is illuminated when a valid audio signal is detected on the associated receiver input.
4. FPGA OK -> FPGA prom load indicator (yellow). This is illuminated when FPGA device is loaded correctly.
5. COMMS -> Communications indicator (yellow). This is illuminated when the Frame Controller

---

Module addresses this card.

6. DS29 -> 5V low indicator (red). This is illuminated when 5V supply falls out of 5% tolerance.

7. DS28 -> 3.3V low indicator (red). This is illuminated when 3.3V supply falls out of 5% tolerance.

8. DS29 -> 1.2V low indicator (red). This is illuminated when 1.2V supply falls out of 5% tolerance.

9. DS29 -> +12V/-12V low indicator (red). This is illuminated when +12V or -12V supplies falls out of 5% tolerance.

This board has high impedance inputs (e.g. 100k ohm). In instances when a 600 ohm input impedance is needed, the factory can strap the inputs to provide the appropriate level.

## DAC Audio Output (121372-1)

The DAC Audio output board receives up to 11 AES3 signals that are passed to the MADI Output board. These signals are individually distributed to the digital to analog converter outputs and after conversion to analog audio are then driven to the system rear panel connectors. The number of signals passed is determined by the slot the board is installed in and the type of rear panel interface used in the system.



Figure 1-9. DAC Audio Output (121372-1)

### ***Controls and Indicators***

There are no controls on this card, other than P1. This is a standard UT400 diagnostic port that provides detailed operational status and control for this card.

There are four types of LED indicators present on the front edge on this card



1. PWR OK -> Power supply indicator (green). This is illuminated when the local power supplies are within tolerance.
2. DS1-21 -> odds and DS22 (Left Signal Presence) -> Signal detection LEDs (green). This is illuminated when a valid audio signal is detected on the associated receiver input.
3. DS2-20 -> evens and DS23 (Right Signal Presence) -> Signal detection LEDs (yellow). This is illuminated when a valid audio signal is detected on the associated receiver input.
4. 5V, 1.2V, 3.3V and +-12V -> Power supply fail indicators (red). Illuminated when local voltages fall out of 5% tolerance.

This board will drive high impedance loads (e.g. 100k ohm). In instances when a 600 ohm load needs to be driven, the factory can make a gain adjustment to this board to provide the appropriate level.

---

## MADI Input (121362-1)

The MADI Input Board is a receiver for a Multichannel Audio Digital Interface.

(MADI/AES10). The MADI receiver supports 64 channels of 48 kHz digital audio. It extracts the AES3 digital audio signals from the MADI stream and distributes them to the output boards. The external interface includes a 75-Ohm BNC input and a Fiber input for the incoming MADI signal. The MADI input signal must be synchronous to the 48 kHz DARS reference provided at the rear of the chassis.

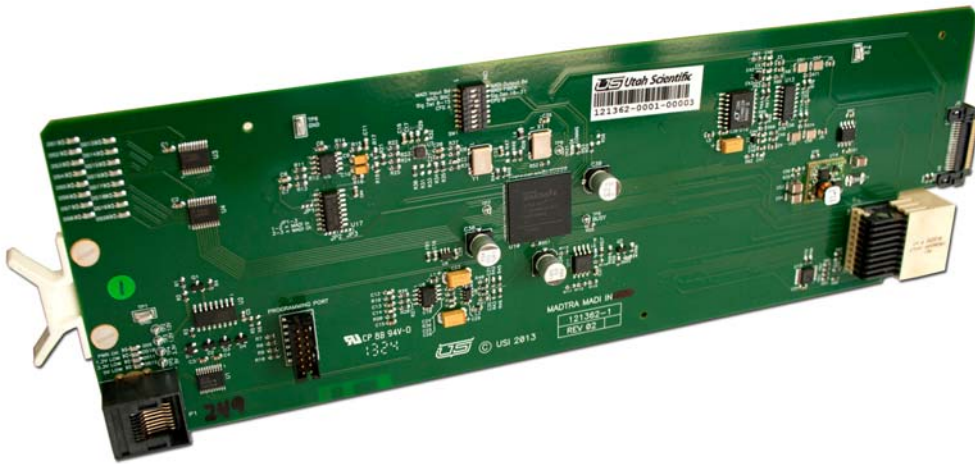

Figure 1-10. MADI Input (121362-1)

### Controls and Indicators

Controls include SW1 and P1. SW1 is an eight pin dipswitch that utilizes switch 1 to determine if the MADI board is configured as an input or output. Switch 2 indicates the MADI input interface as fiber or unbalanced BNC. Switch 3 indicates the group of 16 signal detect LEDs as pairs 1-16 or 17-32. Switch 4 indicates the type of output board interface as balanced (CFG A) or unbalanced (CFG B). The P1 control port is a standard UT400 diagnostic port that provides detailed operational status and control for this card.

There are four types of LED indicators present on the front edge on this card

1. PWR OK -> Power supply indicator (green). This is illuminated when the local power supplies are within tolerance.
2. 1.2V, 3.3V and 5V -> Power supply fail indicators (red). This is illuminated when local voltages fall out of 5% tolerance.





3. DS1-8, 13-20 (SIGDET1-16) -> Signal detection LEDs (green). This is illuminated when a valid digital audio signal is detected on the associated receiver input.

## MADI Output (121362-2)

The MADI Output Board is a transmitter for a Multichannel Audio Digital Interface (MADI/AES10). The MADI transmitter supports 64 channels of 48 kHz digital audio. The 32 AES3 signals are inserted into a MADI stream and output to the 75-Ohm BNC and the Fiber port located on the MADI rear panel.



Figure 1-11. MADI Output (121362-2)

### Controls and Indicators

Controls include SW1 and P1. SW1 is an eight pin dipswitch that utilizes switch 1 to determine if the MADI board is configured as an input or output. Switch 2 indicates the MADI input interface as fiber or unbalanced BNC. Switch 3 indicates the group of 16 signal detect LEDs as pairs 1-16 or 17-32. Switch 4 indicates the type of output board interface as balanced (CFG A) or unbalanced (CFG B). The P1 control port is a standard UT400 diagnostic port that provides detailed operational status and control for this card.

---

There are four types of LED indicators present on the front edge on this card

1. PWR OK -> Power supply indicator (green). This is illuminated when the local power supplies are within tolerance.
2. 1.2V, 3.3V and 5V -> Power supply fail indicators (red). This is illuminated when local voltages fall out of 5% tolerance.
3. DS1-8, 13-20 (SIGDET1-16) -> Signal detection LEDs (green). This is illuminated when a valid digital audio signal is detected on the associated receiver input.

**Note:** *The ADC inputs to the MADl output board provide a 'no audio' AES signal when the audio level is low or not connected that will illuminate the signal detect LEDs.*







## Balanced Digital Audio/Analog Audio (Pinout Connections)

Pair	Pin Number	Signal
1	25	+ IOA 0, 10, 20
	26	- IOB 0, 10, 20
	27	IOC 0, 10, 20
2	21	+ IOA 1, 11, 21
	22	- IOB 1, 11, 21
	20	IOC 1, 11, 21
3	3	+ IOA 2, 12, 22
	2	- IOB 2, 12, 22
	1	IOC 2, 12, 22
4	5	+ IOA 3, 13, 23
	4	- IOB 3, 13, 23
	23	IOC 3, 13, 23
5	7	+ IOA 4, 14, 24
	6	- IOB 4, 14, 24
	24	IOC 4, 14, 24
6	9	+ IOA 5, 15, 25
	8	- IOB 5, 15, 25
	28	IOC 5, 15, 25
7	11	+ IOA 6, 16, 26
	10	- IOB 6, 16, 26
	29	IOC 6, 16, 26
8	13	+ IOA 7, 17, 27
	12	- IOB 7, 17, 27
	30	IOC 7, 17, 27
9	15	+ IOA 8, 18, 28

Chapter

 <p>DB-37 (Female)</p>		 <p>DB-37 (Male)</p>	
	14	- IOB 8, 18, 28	
	34	IOC 8, 18, 28	
10	17	+ IOA 9, 19, 29	
	16	- IOB 9, 19, 29	
	18	IOC 9, 19, 29	
11	35	+ IOA N/A, 30, 31	
	36	- IOB N/A, 30, 31	
	37	IOC N/A, 30, 31	

Pair 11 (above, yellow shading) indicates wired in the I/O slot 2 & 3 *only*.



## Controller (121364-1)

The Controller board has a processor module that communicates to the other boards in the system and it can communicate to external devices through the serial port or Ethernet port. It also has a Timebase module that receives the DARs input and creates clocks for system synchronization.



Figure 1-12. Controller (121364-1)

### ***Controls and Indicators***

Controls include an onboard UT400 diagnostic port (P1) that provides detailed operational status and control for this card. There is also a serial port and Ethernet port that are accessible from the rear panel. The serial port for this board is selectable as RS232 (pins 1-2) or RS422 (pins 2-3) with JP2.

There are two types of LED indicators present on the front edge on this card

1. PWR OK -> Power supply indicator (green). This is illuminated when the local power supplies are within tolerance.
2. 3.3V and +5V/-5V -> Power supply fail indicators (red). Illuminated when local voltages fall out of 5% tolerance.

---

This board contains a timebase module, mounted near the middle, containing two LEDs identified by “Ref OK” and “Loop Lock”. These LEDs will be illuminated when a digital audio reference (DARS) is connected to the rear panel. The DARS signal type is AES3, generated from the plant signal generator from which all other audio signals are locked.

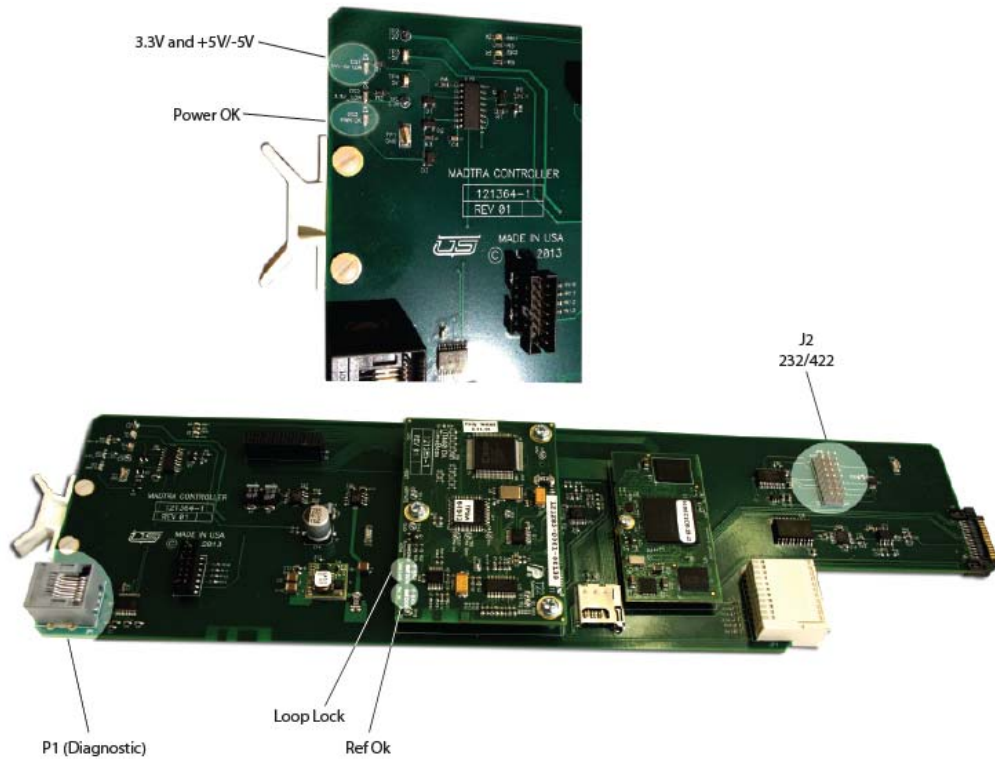

**Figure 1-13. 121364-1 Controls and Indicators**



## Fiber Interface - (Optional)

The MADI System contains the option of using BNC or fiber for the MADI signals. Instead of using BNCs for the physical connection, the system utilizes small modules that plug directly into the rear of the UT-400 chassis.

The small modules are responsible for the electrical-optical conversion, and are removable if service is required.



FIGURE 1-1. SP2T - Transmitter module

The SP2R is the receiver module, and is a part of the MADI Input card assembly. The SP2T is the transmitter module, and is part of the MADI output card assembly. These modules are removed and replaced by moving the swinging bale (at the end) out of, and back in to the locked position.

**Note:** *The board dipswitches will designate BNC or Fiber setup.*

### Specification Detail

- Dual TX or Dual RX
- Non MSA type SFP's
- Connector Type - LC

Typical Cable Length - 18 Miles SD, 10 Miles HD

---

## SFP Use

There are three types of indicators on the card (part # 121234-1, illustrated below).

1. Communications indicator – yellow. Illuminated when the card has been addressed by the Frame Controller Module.
2. PS Fail LED. – Red – Illuminated when the 3.3V power supply falls out of + - 5% tolerance.

Signal Present Detection LED's (12), Green. One of these LEDs is present on the front edge of the card for each input signal. They are labeled as 'Carrier Detect' 1-12. these LED's are only illuminated if a Fiber IO rear panel is fitted, and the Fiber SFP modules report that they are receiving an optical carrier. If no carrier is present, or in the case of a Differential pair input signal from a DA, these LEDs will never be lit.

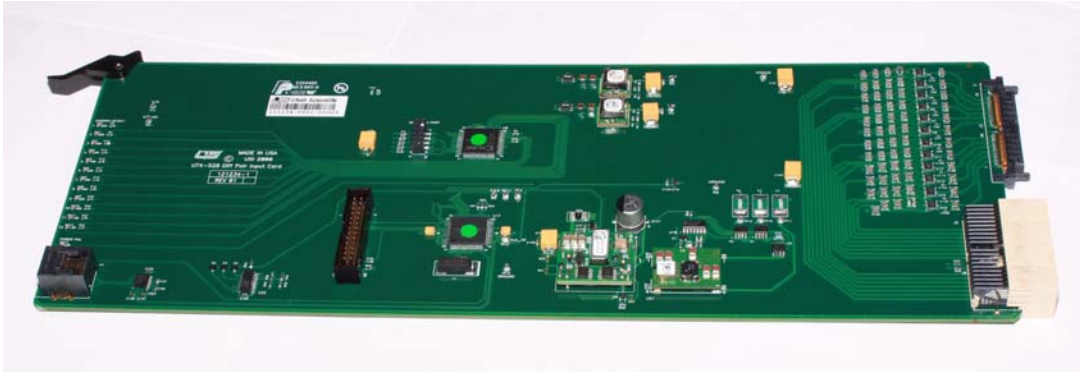
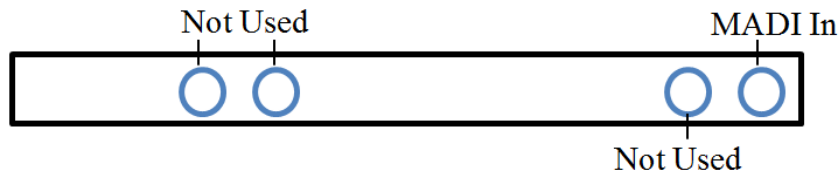

Figure 1-14. 121234-1

## Rear Panel Layout (basic configuration)



- Note that the SFP Ports are either input or output depending upon the type of MADI card and the type of SFP module installed.

Use only NON-MSA pinout dual transmit or dual receive SFP's.



## Specifications

### Digital Audio I/O

Balanced Differential Inputs/Outputs

(75 Ohm Unbalanced I/O option)

Input Impedance: 110 Ohms

Input Level Minimum: 200 mVp-p

Maximum: 7 Vp-p

Maximum Common Mode Level:  $\pm 7$  V (DC-20 kHz)

Output Impedance: 110 Ohms

### Analog Audio I/O

Converter resolution: 24 Bits

Total Harmonic Distortion: 0.1%

(30 Hz to 20 KHz, +24dBm)

Hum and Noise: -85dBm (15KHz weighting)

Crosstalk: -85 dB (20 KHz, +24dBu)

Gain Uniformity: +/- 0.2db

Frequency Response: +/- .25dB

(20 Hz to 20 KHz)

Input Impedance: 200K

Output Source Impedance: <50 ohms

Common mode rejection: 70 dB (50/60 Hz)

### MADI/AES10

I/O Impedance: 75 ohms

Up to:

- 32 pairs of 24 bit, 48 KHz audio

- 
- 100 meters of coaxial cable
  - 2000 meters of optical cable

### **Digital Audio Reference (DARS)**

Input Impedance: 75 ohms

AES3 - 48kHz

### **Power Requirements**

(All supplies are UL-listed and IEC950 approved)

Input: 100-240 VAC, 50-60 Hz

Max Consumption: (power supply capacity)

100 W

### **Physical**

EIA 19" rack space requirements:

2RU (3.5" / 90mm)

All units are 14" deep

### **Environmental**

Operating Temperature Range: 0-45° C

Relative Humidity: 0-90%

(Non-condensing)





---

---

---

## **Symbols**

/O boards 1-1  
+12V/12V low indicator 1-10

## **Numerics**

1.2V low indicator 1-10  
1.2V, 3.3V and 5V 1-12, 1-14  
121360-1 1-7  
121361-1 1-8  
121362-1 1-12  
121362-2 1-13  
121364-1 1-17  
121371-1 1-9  
121372-1 1-10  
2RU chassis 1-1  
3.3V and +5V/-5V 1-17  
3.3V low indicator 1-10  
32 AES3 1-13  
48 kHz 1-1  
48 kHz DARS 1-12  
5V low indicator 1-10  
75-Ohm BNC 1-12, 1-13

## **A**

ADC Audio Input 1-9  
AES 1-1  
AES Audio Input 1-7  
AES Audio Output 1-8  
AES3 1-2, 1-18  
Analog Audio 1-5  
analog audio 1-1

## **B**

Balanced AES 1-4  
Balanced Digital Audio/Analog Audio  
pinout connections 1-15  
BNC 1-2

## **C**

CFG A 1-4, 1-5, 1-6  
CFG B silkscreen 1-3  
COMMS 1-9  
Communications indicator 1-9  
Configuration 1-6  
Controller 1-17  
Controls and Indicators  
121360-1 1-7  
121361-1 1-8  
121362-1 1-12

121362-2 1-13  
121364-1 1-17, 1-18  
121371-1 1-9  
121372-1 1-10  
CPU board 1-1

## **D**

DAC Audio Output 1-10  
DARS 1-1, 1-18  
digital audio 1-1  
DS1-11 1-7  
DS1-21 1-11  
DS1-22 1-9  
DS15-25 1-7  
DS1-8, 13-20 1-14  
DS2-20 1-11  
DS28 1-10  
DS29 1-10  
D-SUB 37 1-4, 1-5

## **E**

Ethernet 1-1

## **F**

Fiber outputs 1-2  
FPGA OK 1-9

## **I**

IOA 1-4

## **J**

JP11-12 1-8  
JP1-9 1-8  
JP2-JP12 1-8

## **L**

Loop Lock 1-18

## **M**

MADI I/O 1-6  
MADI Input 1-12  
MADI Output 1-13  
MADI Translator 1-1  
Multichannel Audio Digital Interface 1-1

## **P**

Pinout Connections 1-15  
power supplies 1-1

---

---

Power supply fail indicators 1-7, 1-11, 1-12, 1-14  
Power supply indicator 1-7, 1-8, 1-9, 1-11, 1-12, 1-14  
PWR OK 1-7, 1-8, 1-9, 1-11, 1-12, 1-14, 1-17

**R**

Ref OK 1-18

**S**

Signal detection LEDs 1-7, 1-9, 1-11, 1-14  
Specification Detail 1-19  
Specifications  
    UT4-528 MADI Input with TDM Board 1-20  
SW1 1-5, 1-6  
SW1 switch 1-3  
Sync detection LEDs 1-7

**T**

Timebase module 1-1

**U**

Unbalanced AES 1-3

**V**

V, 1.2V, 3.3V and +-12V 1-11